

SUMP PUMP

INSTRUCTION AND OPERATING MANUAL



Models

- FSP33CCPV10
- FSP33CCPV20
- FSP33CCPT20
- FSP50CCPV10
- FSP50CCPV20
- FSP50CCPT20

Specifications

Power Supply Requirements	115 VAC, 60 Hz
AMP Rating	4.7 Amps
Temperature Rating	42°F to 95°F
Discharge	1-1/2" NPT

IMPORTANT!

READ ALL INSTRUCTIONS CONTAINED IN THIS MANUAL BEFORE USING THIS PRODUCT.

Save these instructions for future reference. Failure to read and follow the warnings and instructions within this instruction manual could result in property damage, serious injury or death.

SAFETY FIRST!

This instruction manual contains very important information for you to know and understand. This information is provided for your safety and to help prevent equipment problems from occurring. Please observe all safety information labeled danger, warning, caution, and notice.



WARNING

WARNING INDICATES A POTENTIALLY HAZARDOUS SITUATION WHICH, IF NOT AVOIDED, COULD RESULT IN DEATH, SERIOUS INJURY OR MAJOR PROPERTY DAMAGE.

RISK OF ELECTRIC SHOCK. TO REDUCE THIS RISK, OBSERVE THE FOLLOWING WARNINGS:

WARNING! To reduce the risk of electrical shock, this system must be properly grounded in accordance with the National Electric Code (NEC) and all applicable state and local codes and ordinances. The receptacle should be protected with a Ground Fault Circuit Interrupter (GFCI).

WARNING! To reduce the risk of electrical shock, always disconnect the pump / system from the power source BEFORE handling or servicing.

WARNING! Never remove the ground prong from the plug, or use an adapter that eliminates the ground prong.

WARNING! Never plug this pump system into an electric outlet while standing on a wet surface.

WARNING! Cables should be protected at all times to avoid punctures, cuts and abrasions that may result in exposed wiring. Never handle connected power cords with wet hands.

WARNING! The FloodStop® System has not been investigated for use in or around swimming pools, marine areas, recreational water installations, decorative fountains or any installation where human contact with the pumped fluid is common.

WARNING! Do not use an extension cord. Extension cords could present a safety hazard if not properly sized, become damaged or the connection falls into the sump pit. Do not attempt to disassemble the FloodStop® System controller or Backup Pump. There are no field serviceable parts or repair options!



RISK OF EXPLOSION. TO REDUCE THIS RISK, OBSERVE THE FOLLOWING WARNINGS:

WARNING! Do not use to pump flammable or explosive liquids such as gasoline, fuel oil, kerosene, etc.

WARNING! Do not use in a flammable or explosive atmosphere.



NOT SUITED FOR POTABLE WATER APPLICATIONS.

WARNING! Do not use this pump to transfer water that will be used for potable (drinking) water. This pump is only to be used in applications for which it is designed.



CAUTION

CAUTION INDICATES A POTENTIALLY HAZARDOUS SITUATION WHICH, IF NOT AVOIDED, MAY RESULT IN MINOR INJURY OR PROPERTY DAMAGE.

TO REDUCE THE RISK OF HAZARDS THAT CAN CAUSE INJURY OR PROPERTY DAMAGE, OBSERVE THE FOLLOWING WARNINGS:

CAUTION! Do not use discharge hose. Discharge hose may whip under pressure. Use rigid piping and fittings to secure the pump in the sump basin to reduce movement.

CAUTION! Do not install the pump if it has been damaged in any way.

CAUTION! Do not carry or lift the pump by the power cord. Use the pump's lifting handle.



PERFORMANCE

MODEL	HP	GPH of Water @ Total Feet of Lift						Max. Lift
		0 ft.	5 ft.	10 ft.	15 ft.	20 ft.	25 ft.	
FSP33CCPV10 FSP33CCPV20 FSP33CCPT20	1/3	3800	3400	3000	2500	1800	0	25 ft.
FSP50CCPV10 FSP50CCPV20 FSP50CCPT20	1/2	4300	3900	3500	3100	2500	1700	30 ft.

PRE-INSTALLATION

APPLICATION

- This submersible sump pump is designed for home sump applications. Use this pump only for pumping water.
- This unit is not designed as a waterfall or fountain pump, or for applications involving salt water or brine! Use with waterfalls, fountains, salt water or brine will void warranty.
- Do not use where water recirculates.
- Not designed for use as a swimming pool drainer

TOOLS REQUIRED

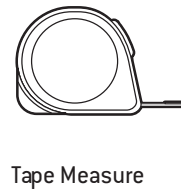
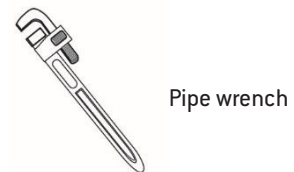
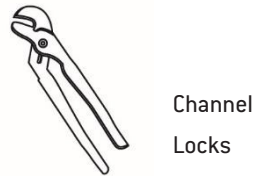
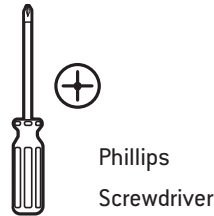
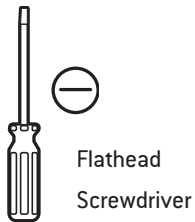

MATERIALS REQUIRED (NOT INCLUDED)

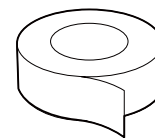
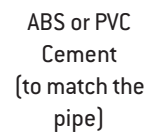
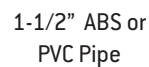
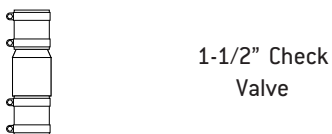
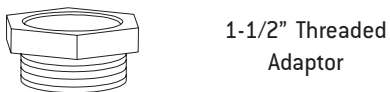

NOTE: Parts are not shown to scale.

INSTALLATION

1. Set the pump on a solid, level surface in the bottom of the sump pit. If necessary, use a pump stand to provide a solid base. Avoid placing the pump on loose gravel, earth or sand.
2. Install discharge plumbing according to state and local codes. It is highly recommended that rigid PVC is used for the discharge line. Installing a union in the discharge line will make it easier to remove the sump pump for maintenance. The discharge line must be sloped downward away from the foundation to ensure that the water properly drains away and that the discharge line will not freeze during cold spells.
3. Install a check valve in the discharge line. The check valve may be positioned just above the sump basin for ease of service and/or replacement.
4. If applicable, assemble the switch to the discharge line using the attached hose clamp. Position the switch so that when the float is at its lowest position it is at least 3" above the base of the pump (just above the inlet). Make sure that the switch is positioned where the float can move up and down freely.
5. Secure power cord to the discharge pipe using cable ties to prevent switch entanglement.
6. Plug the power cord into a ground fault circuit interrupter (GFCI) protected outlet.
7. Fill the sump basin with water until the float rises and starts the pump cycle. The pump will stop when the water level falls to the switch's off position. Repeat this several times to ensure proper operation and that the switch operates freely.
8. Install the sump basin gasket / cover.



NOTICE

This pump was not designed to handle salt water, brine, laundry discharge, water softener discharge or any other application that may contain caustic chemicals. Damage to the pump may occur and will void the pump's warranty.

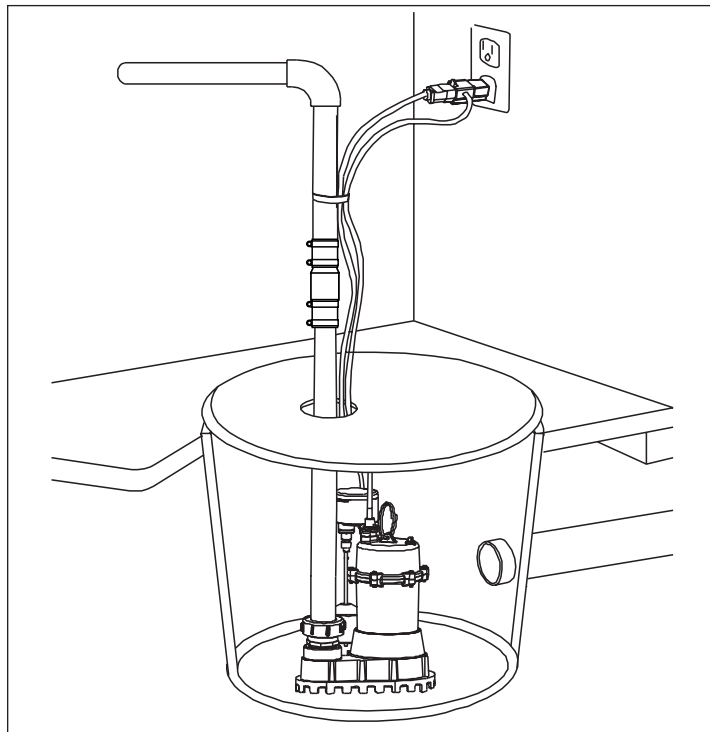

CARE AND CLEAN

CAUTION: Always use the handle to lift the pump. Never use the power cord to lift the pump. To avoid skin burns, unplug the pump and allow time for it to cool after periods of extended use.

DO

- When the power is disconnected, inspect the pump suction screen and remove all debris, then plug the pump back into the grounded (GFCI) outlet.

DO NOT

- Do not disassemble the motor housing. This motor has NO repairable internal parts, and disassembly may cause leakage or dangerous electrical wiring issues.
- Do not lift the pump by the power cord.

TO CLEAN A PUMP WITH CLOGGED DEBRIS

- Unplug the pump from electrical power.
- Unscrew the stainless screws, and remove the base & gasket.
- Use a flathead screwdriver to hold the shaft, then turn the impeller counterclockwise to release the impeller.
- Remove debris from around the shaft and on/under the impeller.
- Reassemble the pump.

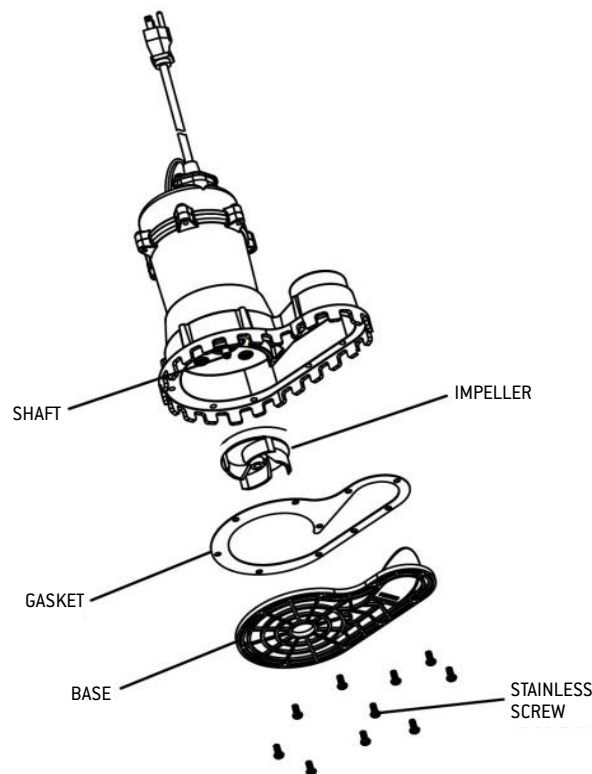

TROUBLESHOOTING



CAUTION

CAUTION INDICATES A POTENTIALLY HAZARDOUS SITUATION WHICH, IF NOT AVOIDED, MAY RESULT IN MINOR INJURY OR PROPERTY DAMAGE.

PROBLEM	POTENTIAL CAUSE	POSSIBLE SOLUTION
Pump Will Not Run	<ol style="list-style-type: none"> 1. Blown fuse, tripped breaker or tripped GFCI 2. Low Line Voltage 3. Switch obstructed 4. Insufficient water level 5. Motor Failure 6. Switch Failure 	<ol style="list-style-type: none"> 1. Check all electrical connections. Check for blown fuses, tripped GFCI or tripped circuit breaker. 2. Contact a licensed electrician. 3. Remove obstruction and check for free movement. 4. Water needs to rise to a level that activates the switch. 5. Replace pump. 6. Replace switch.
Pump Cycles too frequently	<ol style="list-style-type: none"> 1. Switch Failure 2. Check valve not present or not operating properly 	<ol style="list-style-type: none"> 1. Replace switch. 2. Install or replace the check valve.
Pump Shuts off and turns on independent of switch (trips thermal overload protector). CAUTION! Pump may start unexpectedly. Disconnect power supply.	<ol style="list-style-type: none"> 1. Switch failure 2. Switch obstructed 3. Inlet blocked or discharge blocked 4. Excessive inflow or pump not properly sized 	<ol style="list-style-type: none"> 1. Replace switch. 2. Remove obstruction and check for free movement. 3. Clean pump inlet. Check and remove any obstructions from the pump discharge line. 4. Recheck all sizing calculations to determine proper size.
Pump runs continuously	<ol style="list-style-type: none"> 1. Impeller obstructed or damaged 2. Piping attachments too rigid or too loose to building structure 	<ol style="list-style-type: none"> 1. Clean and / or replace impeller. 2. Install a rubber coupling to isolate pump vibration for discharge line.
Pump operates noisily or vibrates excessively	<ol style="list-style-type: none"> 1. Impeller obstructed or damaged 2. Piping attachments too rigid or too loose to building structure 	<ol style="list-style-type: none"> 1. Clean and / or replace impeller. 2. Install a rubber coupling to isolate pump vibration for discharge line.
Pump runs but delivers insufficient capacity	<ol style="list-style-type: none"> 1. Low line voltage 2. Impeller obstructed, worn or damaged 3. Inlet blocked or discharge blocked 4. Pump undersized for application 5. Check valve stuck closed or installed backwards 	<ol style="list-style-type: none"> 1. Contact a licensed electrician. 2. Clean and / or replace impeller. 3. Clean pump inlet. Check and remove any obstructions from the pump discharge line. 4. Recheck all sizing calculations to determine proper size. 5. Remove and examine check valve.



500 Distribution Parkway
Collierville, TN 38017
Phone: 800-888-8312
Fax: 901-853-5008
www.ipscorp.com

85723-01